

Dell Embedded Box PC 3000 Installation and Operation Manual

Computer Model: Dell Embedded Box PC 3000
Regulatory Model: N02PC
Regulatory Type: N02PC001



Notes, cautions, and warnings

 **NOTE:** A NOTE indicates important information that helps you make better use of your product.

 **CAUTION:** A CAUTION indicates either potential damage to hardware or loss of data and tells you how to avoid the problem.

 **WARNING:** A WARNING indicates a potential for property damage, personal injury, or death.

Contents

1 Overview.....	5
2 Features.....	6
Top view.....	6
Bottom view.....	6
VGA connector mapping.....	7
RS232 connector mapping.....	8
RS485 connector mapping.....	8
CANbus connector mapping.....	8
DC power port.....	9
RS422 connector mapping.....	9
System LEDs.....	10
3 Setting up the Embedded Box PC.....	11
Mounting the Embedded Box PC on the wall using the wall-mount brackets.....	13
Mounting the Embedded Box PC on a DIN rail.....	15
4 Setting up your operating system.....	17
Ubuntu Desktop.....	17
Reinstalling Ubuntu Desktop.....	17
Restoring Ubuntu Desktop.....	18
Restoring Ubuntu Desktop on the Embedded Box PC from the recovery USB flash drive.....	18
Creating the bootable USB flash drive.....	18
Creating the recovery USB flash drive.....	18
Windows OS.....	18
Windows 7 Professional SP1.....	18
Windows 7 Professional for Embedded Systems SP1.....	21
Windows Embedded Standard 7 P/E.....	22
Windows 10 Professional.....	24
Windows 10 IoT Enterprise LTSC 2015.....	25
Recommended drivers and applications for Embedded Box PC running Windows operating system.....	27
5 Specifications.....	30
6 Activating your mobile broadband service.....	33
7 Using the Multi-function port cable.....	34
8 Setting up the ZigBee Dongle.....	37
9 Connector kit.....	38
Remote Power Connector.....	38



10 BIOS defaults.....	39
General.....	39
System configuration (BIOS level 1).....	41
Video.....	42
Security (BIOS level 1).....	42
Secure boot.....	43
Intel software guard extensions.....	44
Performance.....	44
Power management.....	44
POST behavior.....	45
Virtualization support (BIOS level 1).....	45
Wireless.....	45
Maintenance.....	45
System logs.....	46
11 Contacting Dell.....	47



Overview

The Embedded Box PC 3000 enables you to connect your devices (wired or wireless) to network-enabled devices and manage them remotely in your existing network ecosystem. It enables you to connect with devices used in process and discrete manufacturing, fleet management, kiosks, digital signage, surveillance, and automated retail solutions. It can be either mounted on the wall using the Dell approved wall mount kits or mounted into your existing rack infrastructure using the Rail mount. It supports Windows 7 Professional SP1 64-bit, Windows 7 Professional for Embedded Systems SP1 64-Bit, Windows Embedded Standard 7 P/E 64-bit, Windows 10 Professional 64-bit, Windows 10 IoT Enterprise LTSB 2015 64-bit, and Ubuntu Desktop 16.04 operating systems.



Features

Top view

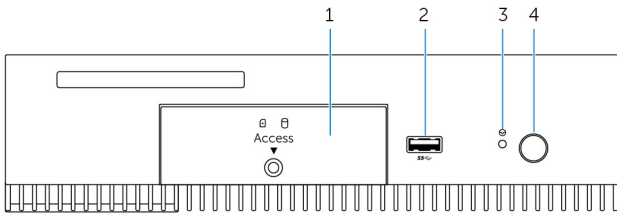

Features

1	Front access door	Loosen the captive screw that secures the front access door to the chassis. Remove the front access door to access the hard drive, solid-state drive, or SIM-card slot.
2	USB 3.0 port	Connect a USB enabled device. Provides data transfer speeds up to 5 Gbps.
3	Hard reset	Using a pin, press the button located inside the pin hole to restart the Embedded Box PC.
4	Power button	Press to turn on or off the Embedded Box PC.

Bottom view

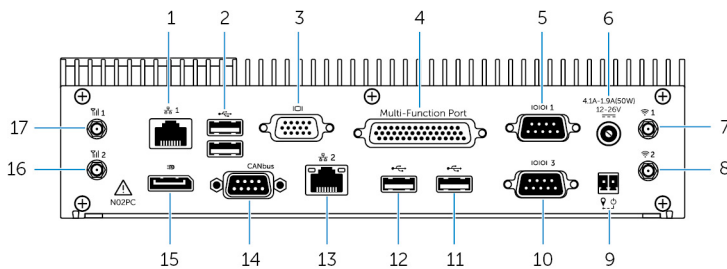

Features

1	Network port one	Connect an Ethernet (RJ45) cable for network access. Provides data transfer speeds up to 10/100/1000 Mbps.
2	USB 2.0 ports (2)	Connect USB enabled devices. Provides data transfer speeds up to 480 Mbps.
3	VGA port	Connect a monitor or another VGA enabled device. Provides video output. For more information, see VGA connector mapping.
4	Multi-function port (female)	Connect Multi-function port cable (optional). For more information, see Using the Multi-function port cable .

Features

5	RS232/RS485 port one (configurable in the BIOS)	Connect a RS232/RS485 cable to the Embedded Box PC. For more information, see RS232/RS485 connector mapping.
6	12-26V DC power port	Connect a 12-26V DC power cable for supplying power to the Embedded Box PC. For more information about the physical dimensions of the DC power port, see DC power port .
7	Wireless antenna port one	Connect a wireless antenna to increase the range and strength of the wireless signals.
8	Wireless antenna port two	Connect a wireless antenna to increase the range and strength of the wireless signals.
9	Remote power switch ¹	Install a remote power switch.
10	RS232/RS485 port three (configurable in the BIOS)	Connect a RS232/RS485 cable to the Embedded Box PC. For more information, see RS232/RS485 connector mapping.
11	USB 2.0 port	Connect a USB enabled device. Provides data transfer speeds up to 480 Mbps.
12	USB 2.0 port	Connect a USB enabled device. Provides data transfer speeds up to 480 Mbps.
13	Network port two	Connect an Ethernet (RJ45) cable for network access. Provides data transfer speeds up to 10/100/1000 Mbps.
14	CANbus port (optional)	Connect to a CANbus port enabled device or dongle. For more information, see CANbus connector mapping.
15	DisplayPort	Connect a monitor or another DisplayPort enabled device. Provides video and audio output.
16	Mobile broadband antenna port two	Connect a mobile broadband antenna to increase the range and strength of the mobile broadband signals.
17	Mobile broadband antenna port one	Connect a mobile broadband antenna to increase the range and strength of the mobile broadband signals.

¹ Connections made to these ports must use SELV circuits and the wire (26 AWG-18 AWG) must have Double Insulation (DI) or Reinforced Insulation (RI) to protect it from all hazardous voltages. Torque the screws at 2.88 kg-cm (2.5 lb-in) to secure the wire to the connector.

VGA connector mapping

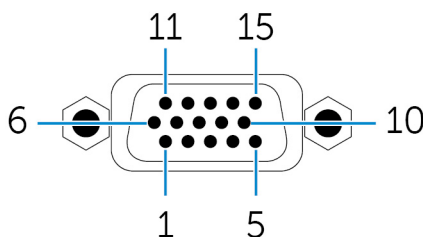

Pin	Signal	Pin	Signal	Pin	Signal
1	RED	6	GND	11	NC
2	GREEN	7	GND	12	DDCDAT
3	BLUE	8	GND	13	HSYNC
4	NC	9	+5V	14	VSYS



Pin	Signal	Pin	Signal	Pin	Signal
5	GND	10	GND	15	DDCCLK

RS232 connector mapping

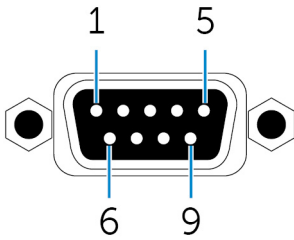

Pin	Signal	Pin	Signal
1	DCD	6	DSR
2	RXD	7	RTS
3	TXD	8	CTS
4	DTR	9	RI
5	GND		

RS485 connector mapping

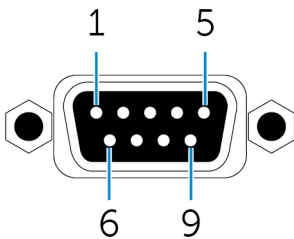

Pin	Signal	Pin	Signal
1	DATA-	6	NC
2	DATA+	7	NC
3	NC	8	NC
4	NC	9	NC
5	GND		

CANbus connector mapping

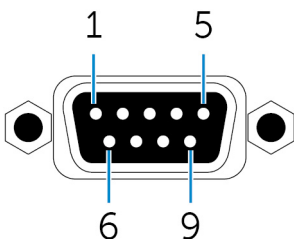

Pin	Signal	Pin	Signal
1	NC	6	NC
2	CAN_L	7	CAN_H
3	GND	8	NC
4	NC	9	NC
5	NC		

DC power port

The following figure shows the physical dimensions of the DC power port.

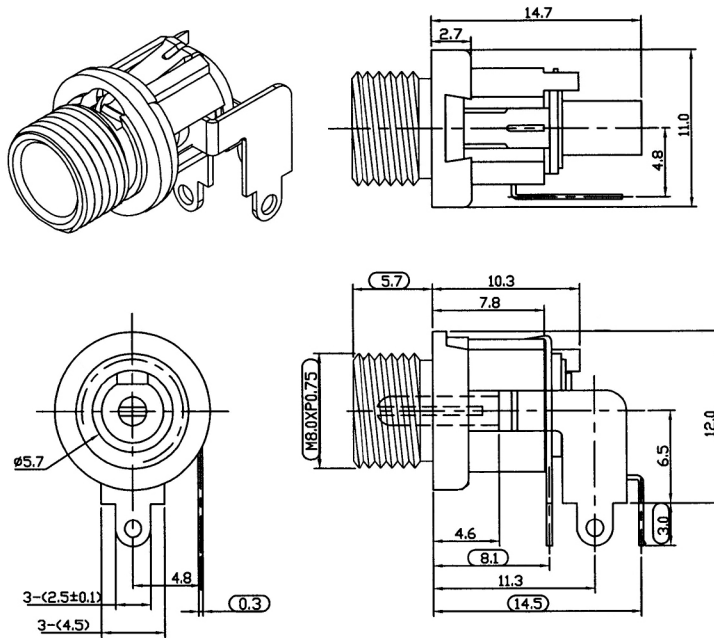

RS422 connector mapping

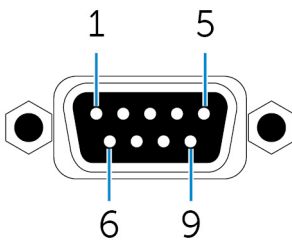

Pin	Signal	Pin	Signal
1	TX-	6	NC
2	TX+	7	NC
3	RX+	8	NC
4	RX-	9	NC
5	GND		



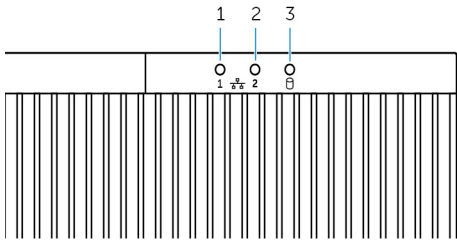









System LEDs



Feature

1	Network status light one	Indicates the network activity of network port one.
2	Network status light two	Indicates the network activity of network port two.
3	Hard-drive activity light	Indicates the read/write activity from the internal storage device.

Setting up the Embedded Box PC

-  **WARNING:** During the installation of the Embedded Box PC, the responsible party or integrator must use the power adapter provided with the Embedded Box PC. Always ensure that the available power source matches the required input power of the Embedded Box PC. Check the input power markings next to power connector(s) before making connections.
-  **WARNING:** Before you begin any of the procedures in this section, read the safety information that shipped with your Embedded Box PC. For additional best practices information, go to www.dell.com/regulatory_compliance.
-  **WARNING:** To ensure that the protection provided by the Embedded Box PC is not impaired, do not use or install the Embedded Box PC in any manner other than what is specified in this manual.
-  **WARNING:** To provide additional power connections to the main network, use cables appropriate for the load currents such as, 3-core cable rated 15 A at 90°C (194°F) minimum, which conform to either IEC 60227 or IEC 60245. The Embedded Box PC accepts cables from 0.8 mm to 2.5 mm (18 AWG to 14 AWG).
-  **WARNING:** The symbol  indicates hot surface or adjacent hot surface that can obtain temperature during normal use that can cause a burn. Allow equipment to cool off or use protective gloves when handling to reduce risk of a burn.
-  **WARNING:** This product is designed for specific applications and must be installed by qualified personnel with RF and regulatory related knowledge. The general user must not attempt to install or change the setting.
-  **WARNING:** The product shall be installed at a location where the radiating antenna is kept 20 cm away from nearby persons in its normal operating condition to meet regulatory RF exposure requirements.
-  **WARNING:** Use only those antenna(s) that are approved by Dell.
-  **WARNING:** Select the installation position carefully and ensure that the final output power does not exceed the limits present in relevant rules. The violation of these rules could possibly lead to serious federal penalties.
-  **WARNING:** Connect a certified SELV power source to the Embedded Box PC.
-  **WARNING:** If your equipment or accessories are provided with a detachable main supply cord set and has to be replaced, ensure that the replacement cord set has an adequate voltage, current, and temperature rating for the country where the equipment is installed. The cord set must comply to the local safety code, regulations, and law.

Professional installation instructions

Installation personnel

This product is designed for specific applications and needs to be installed by qualified personnel with RF and regulatory related knowledge. The general user shall not attempt to install or change the setting.

Installation location

The product shall be installed at a location where the radiating antenna is kept 20 cm from nearby persons in its normal operation condition in order to meet regulatory RF exposure requirements.

External antenna

Use only the antenna(s) which have been approved by the applicant. Non-approved antenna(s) may produce unwanted spurious or excessive RF transmitting power which may lead to a violation of FCC/IC limits and is prohibited.

Installation procedure



Please refer to user's manual for the detail.

WARNING: Please carefully select the installation position and make sure that the final output power does not exceed the limits set forth in relevant rules. The violation of these rules could possibly lead to serious federal penalties.

Federal Communication Commission Interference Statement

This device complies with Part 15 of the FCC Rules. Operation is subject to the following two conditions: (1) This device may not cause harmful interference, and (2) this device must accept any interference received, including interference that may cause undesired operation.

This equipment has been tested and found to comply with the limits for a Class B digital device, pursuant to Part 15 of the FCC Rules. These limits are designed to provide reasonable protection against harmful interference in a residential installation. This equipment generates, uses and can radiate radio frequency energy and, if not installed and used in accordance with the instructions, may cause harmful interference to radio communications. However, there is no guarantee that interference will not occur in a particular installation. If this equipment does cause harmful interference to radio or television reception, which can be determined by turning the equipment off and on, the user is encouraged to try to correct the interference by one of the following measures:

- Reorient or relocate the receiving antenna.
- Increase the separation between the equipment and receiver.
- Connect the equipment into an outlet on a circuit different from that to which the receiver is connected.
- Consult the dealer or an experienced radio/TV technician for help.

FCC Caution:

- Any changes or modifications not expressly approved by the party responsible for compliance could void the user's authority to operate this equipment.
- This transmitter must not be co-located or operating in conjunction with any other antenna or transmitter.

Radiation Exposure Statement:

This equipment complies with FCC radiation exposure limits set forth for an uncontrolled environment. This equipment should be installed and operated with minimum distance 20cm between the radiator & your body.

NOTE: The country code selection is for non-US model only and is not available to all US model. Per FCC regulation, all WiFi product marketed in US must fixed to US operation channels only.

Industry Canada Statement

This device complies with Industry Canada license-exempt RSS standard(s). Operation is subject to the following two conditions:

1. this device may not cause interference, and
2. this device must accept any interference, including interference that may cause undesired operation of the device.

Setting up the Embedded Box PC

1. Install the Embedded Box PC on a vertical surface like a wall using the [wall-mount brackets](#) or the [DIN-rail brackets](#).
2. Connect to your network in one of the following methods:

- Connect the network cable.

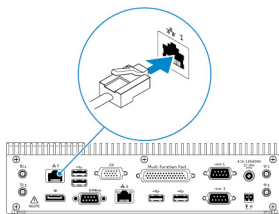

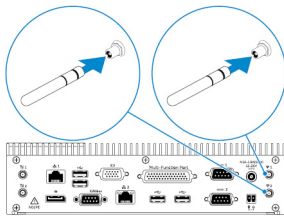

- Install the wireless antennas (WLAN 1 and WLAN 2) to enable the wireless connection.

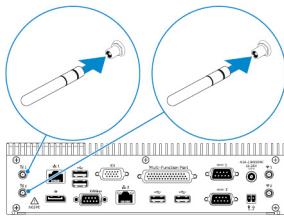

- Install the mobile broadband kit (WWAN 1 and WWAN 2) to enable the mobile broadband connection.



-  **NOTE:** For more information about connecting the wireless antenna to Embedded Box PC, see the documentation that is shipped with the wireless antenna.
-  **NOTE:** For more information about installing the WWAN card in the Embedded Box PC, see the *Embedded Box PC Service Manual* at www.dell.com/support.
-  **NOTE:** Peripherals such as the wireless antenna, keyboard, and mouse are sold separately.

3. Connect the devices to the I/O ports on the Embedded Box PC.
4. Connect the power adapter and tighten the sleeves on the adapter pin to secure it to the Embedded Box PC.

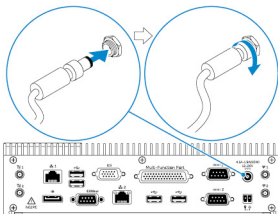

5. Turn on the Embedded Box PC, and complete the operating system setup.
6. Configure the I/O ports on the Embedded Box PC.

Mounting the Embedded Box PC on the wall using the wall-mount brackets

Mount the Embedded Box PC on a wall by using the wall-mount brackets.

-  **NOTE:** The mounting brackets are shipped with only those screws that are required for securing the mounting brackets to the back of the Embedded Box PC.

1. Slide the mounting brackets into the back of the Embedded Box PC.

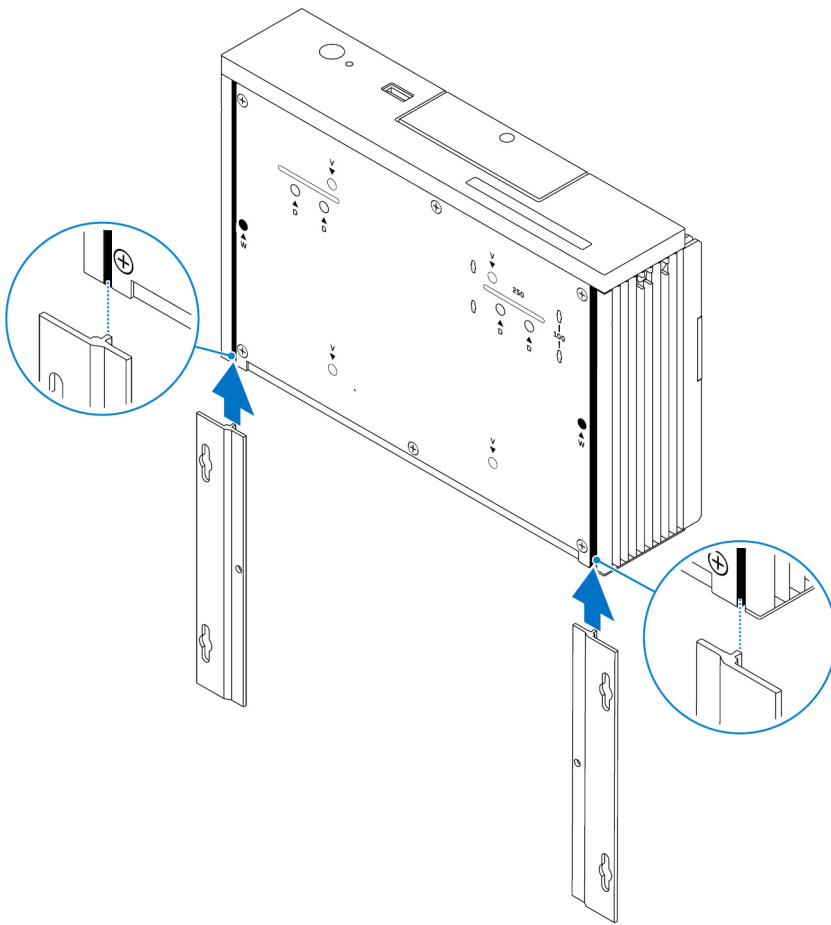

2. Secure the two mounting brackets to the back of the Embedded Box PC by using two M3x5 screws.

 **NOTE: Torque the screws at 3 to 3.4 kilograms-centimeter (2.6 to 3.0 pounds-inch).**

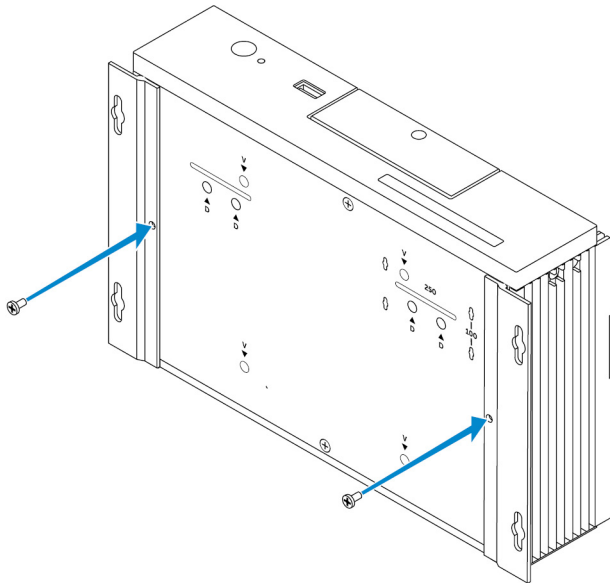

3. Drill four holes in the wall that correspond to the holes on the mounting brackets.
4. Place the Embedded Box PC against the wall and align the holes on the mounting brackets with the holes on the wall.

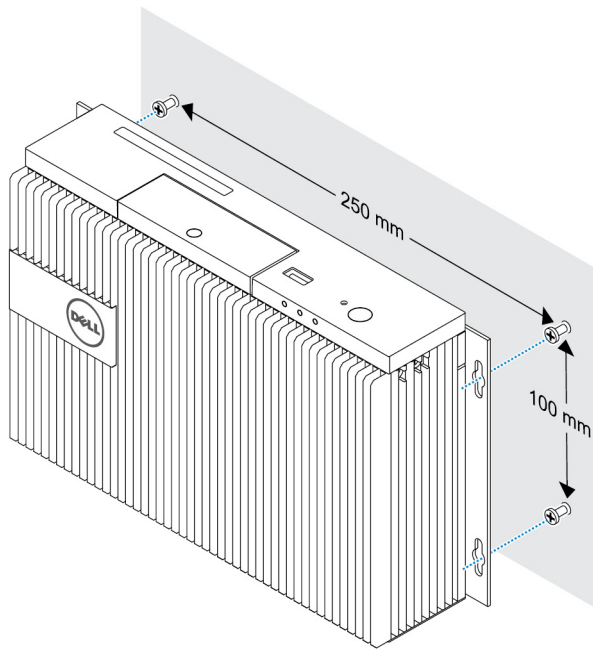

5. Secure the Embedded Box PC to the wall.

 **NOTE: Torque the screws (M4x6) at 5 to 5.4 kilograms-centimeter (4.3 to 4.7 pounds-inch).**

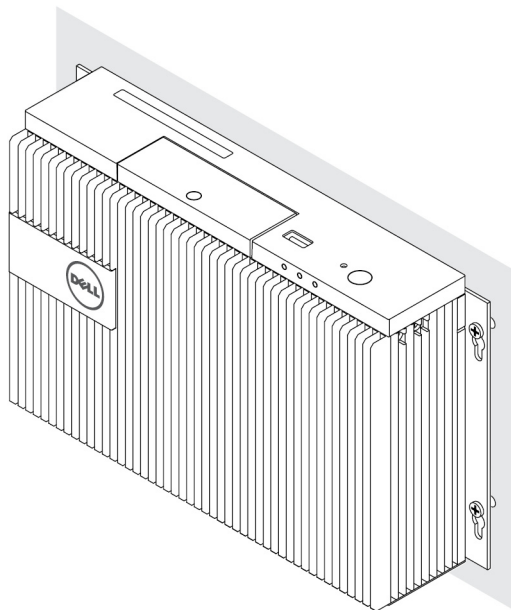

Mounting the Embedded Box PC on a DIN rail

The Embedded Box PC can be mounted on a DIN rail by using DIN-rail clips.

Hardware required for DIN-rail

- Two DIN-rail clips
- Two M4x7 screws (Screw pitch 18 mm)

DIN-rail mounting holes:



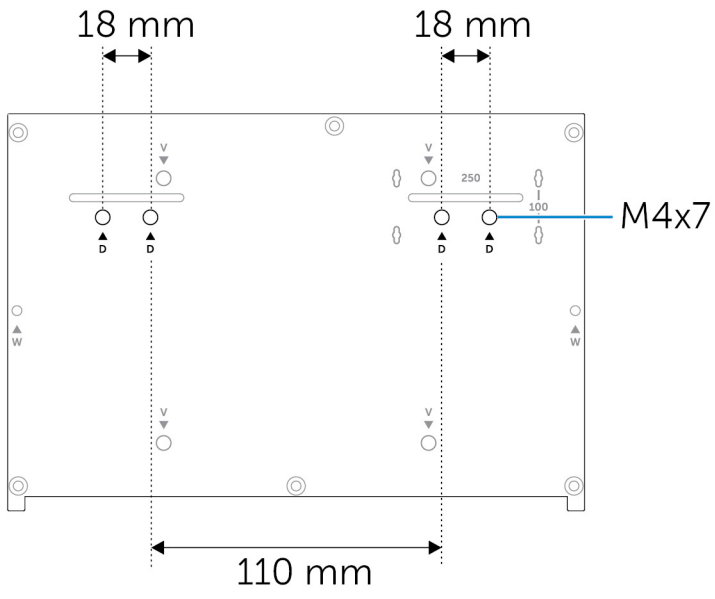

Setting up your operating system



WARNING: To prevent operating system corruption from sudden power loss, use the operating system to gracefully shut down the Embedded Box PC.

The Embedded Box PC is shipped with one of the following operating systems:

- Windows 7 Professional SP1 64-bit
- Windows 7 Professional for Embedded Systems SP1 64-Bit
- Windows Embedded Standard 7 P 64-bit
- Windows Embedded Standard 7 E 64-bit
- Windows 10 Professional 64-bit
- Windows 10 IoT Enterprise LTSB 2015 64-bit
- Ubuntu Desktop 16.04



NOTE: For more information about Windows operating systems, see msdn.microsoft.com.



NOTE: For more information about Ubuntu Desktop operating system, see www.ubuntu.com/desktop.

Ubuntu Desktop

Reinstalling Ubuntu Desktop

Before reinstalling Ubuntu Desktop, ensure the following:

- Connect a keyboard, mouse, and monitor to the Embedded Box PC, or connect to the Embedded Box PC through a KVM session, Dell Wyse Cloud Client Manager (CCM), or Dell Command | Monitor (DCM).
- Create a [bootable USB flash drive](#).



NOTE: For more information about using the CCM, see the CCM documentation available at www.cloudclientmanager.com.



NOTE: For more information about using the DCM, see the DCM documentation available at www.dell.com/clientsystemsmanagement.



NOTE: Dell recommends that you create a [recovery USB flash drive](#) before installing Ubuntu Desktop for the first time.

Follow these steps to reinstall Ubuntu Desktop:

1. Insert the bootable Ubuntu Desktop USB flash drive.
2. Turn on the Embedded Box PC.
3. Press F12 to access the boot menu.
4. Enable **UEFI boot mode** in System Setup and boot from the Ubuntu Desktop USB flash drive.
5. Select **Dell recovery** to start the Ubuntu Desktop installation.
6. Select the drive onto which you want to install the Ubuntu Desktop operating system.
7. After the installation is complete, restart the Embedded Box PC.
8. Follow the instructions on the screen to configure the **Language, License Agreement, Location, Keyboard Layout**, and **User name/password** settings.



The Embedded Box PC restarts to boot Ubuntu Desktop successfully.

Restoring Ubuntu Desktop

You can restore Ubuntu Desktop on the Embedded Box PC to a new condition if you encounter any of the following situations:

- You are unable to start Ubuntu Desktop
- The Ubuntu Desktop operating system is damaged

Before restoring, create a recovery USB flash drive with the backup image.

Restoring Ubuntu Desktop on the Embedded Box PC from the recovery USB flash drive

1. Insert the recovery USB flash drive into the Embedded Box PC.
2. Turn on the Embedded Box PC.
3. Press F12 to access the boot menu.
4. Enable **UEFI boot mode** in System Setup and boot from the Ubuntu Desktop USB flash drive.
5. Select **Dell recovery** to start Ubuntu Desktop recovery.
6. Select the disk onto which you want to install the Ubuntu Desktop operating system.
7. After the installation is complete, restart the Embedded Box PC.
8. Follow the instructions on the screen to complete the **Language, License Agreement, Location, Keyboard Layout, and User name/Password** settings.

The Embedded Box PC restarts to boot Ubuntu Desktop successfully.

Creating the bootable USB flash drive

1. Download the Ubuntu Desktop ISO image from www.ubuntu.com/download/desktop.
2. Follow the instructions provided at www.ubuntu.com/download/desktop/create-a-usb-stick-on-windows.
3. Reinstall the Ubuntu Desktop operating system from the bootable USB flash drive.

Creating the recovery USB flash drive

Create a recovery disk when installing Ubuntu Desktop for the first time.

1. Turn on the Embedded Box PC.
2. Follow the instructions on the screen when you start the Embedded Box PC for the first time.
3. Select **Language**, and click **Continue**.
4. Agree to the license agreement, and click **Continue**.
5. Select a location, and click **Continue**.
6. Select the keyboard layout, and click **Continue**.
7. Enter the user name and password, and then click **Continue**.
8. Insert a USB flash drive with 2 GB or more space to create the recovery USB flash drive, and then click **Continue**.
9. To create a startup disk, select **USB stick user plugged**, and then click **Make Startup Disk**.

The recovery USB flash drive is created.

Windows OS

Windows 7 Professional SP1

Overview

The Embedded Box PC is shipped with Windows 7 Professional SP1. For more information, see <https://support.microsoft.com/en-us>.

Boot up and log in

Before configuring the Windows 7 Professional SP1, connect a keyboard, mouse, and monitor to the Embedded Box PC. Turn on the Embedded Box PC to boot into Windows.

1. Select regional settings.
2. Create a user account.
3. Read and agree to applicable End User Licence Agreements.
4. Select your preferred settings.

 **NOTE: Connect to a wireless network if available.**

Restoring Windows 7 Professional SP1

You can restore Windows 7 Professional SP1 on the Embedded Box PC by using the recovery OS image on the boot partition, which resets the run-time image back to the factory image.

Connect a keyboard, mouse, and monitor to the Embedded Box PC. Boot to the recovery environment by following these steps:

1. Turn off your computer.
2. Turn on the Embedded Box PC.
3. When the Dell logo appears on the screen, press F8 several times to open the **Advanced Boot Options** menu.
4. Use the arrow keys to select **Repair Your Computer** and press **Enter**.
5. From the **System Recovery Options** menu, select a keyboard layout, and then click **Next**.
6. On the next screen, log in as a local user or the Administrator.
7. From the **Recovery options** menu, select **Factory Image Restore**.
8. Click **Next** to open the **Confirm Data Deletion** menu.
9. Select the **Yes, reformat hard drive and restore system software to factory condition** check box and click **Next**.
10. After the restore operation is complete, click **Finish** to restart the computer.

Windows 7 Professional SP1 basic functions

BIOS update

BIOS updates for the Embedded Box PC may be downloaded from dell.com/support. The download includes an executable that may be ran from the local machine.

Watchdog Timer

The Watchdog Timer for Windows 7 Professional SP1 is controlled through a BIOS setting. Enter the BIOS during boot by pressing F2. Select **System Configuration** → **Watchdog Timer Support** → **Enable Watchdog Timer** in the BIOS setup program.

The Watchdog Timer feature is used to recover the operating system during the following instances:

- During POST of the computer to ensure that the computer initialization is completed properly by the BIOS/UEFI.
- During the transition from BIOS/UEFI to the operating system through an operating system Watchdog Timer driver.

In both instances, without any human intervention, the Watchdog Timer reacts when the computer is not responding. The Watchdog Timer is enabled and disabled under the BIOS setting **Watchdog Timer**.

TPM support

Windows 7 Professional SP1 supports TPM 1.2. For more information about TPM resources, see [https://technet.microsoft.com/en-us/library/cc749022\(v=ws.10\).aspx](https://technet.microsoft.com/en-us/library/cc749022(v=ws.10).aspx).



System shutdown

Click **Start**, and then click **Shut down** to shut down the Embedded Box PC.

System restart

Click **Start**, and click the arrow next to **Shut down**, and then click **Restart** to restart the Embedded Box PC.

LAN network configuration

1. Click **Start** and type `Network` in the search box.
2. Click **Network and Sharing Center** from the search result.
The **Network and Sharing Center** window appears.
3. From the left panel, click **Change adapter settings**.

WLAN network configuration

1. Click **Start** and type `Network` in the search box.
2. Click **Network and Sharing Center** from the search result.
The **Network and Sharing Center** window appears.
3. From the left panel, click **Change adapter settings**.

Bluetooth configuration

1. Click **Start** and type `Bluetooth` in the search box.
2. Click **Change Bluetooth settings** from the search result.
The **Bluetooth Settings** dialog box appears.

DW5580 network configuration

Follow the *Service Manual* to install and configure the DW5580 module and the corresponding carrier SIM card for the system. Once the module and the SIM card are installed, follow these steps to connect and disconnect from WWAN.

1. Click **Start** and type `Network` in the search box.
2. Click **Network and Sharing Center** from the search result.
The **Network and Sharing Center** window appears.
3. From the left panel, click **Change adapter settings**.
4. Locate the required WWAN connection.
5. Right-click the WWAN connection, and then select **Connect** or **Disconnect** to connect to or disconnect from the WWAN adapter, respectively.

Common port mappings

Serial port mapping

The following table shows the serial port mapping at the bottom of the Embedded Box PC 3000 with the Dell factory installed Windows 7 Professional SP1 OS image.

Table 1. Serial port mapping

Number	Port Type	Connector	Device Node
1	RS232/485	DB9	COM1
2	Multi-function port (RS232/422)	7-in-1 cable	COM2
3	RS232/485	DB9	COM3

Windows 7 Professional for Embedded Systems SP1

Overview

The Embedded Box PC is shipped with Windows 7 Professional for Embedded Systems. For more information, see <https://www.microsoft.com/windowsembedded/en-us/windows-embedded-enterprise-7.aspx>.

Boot up and log in

Before configuring the Windows 7 Professional for Embedded Systems, connect a keyboard, mouse, and monitor to the Embedded Box PC. Turn on the Embedded Box PC to boot into Windows.

1. Select regional settings.
2. Create a user account.
3. Read and agree to applicable End User Licence Agreements.
4. Select your preferred settings.

 **NOTE: Connect to a wireless network if available.**

Windows 7 Professional for Embedded Systems basic functions

Watchdog Timer

The Watchdog Timer for Windows 7 Professional for Embedded Systems is controlled through a BIOS setting. Enter the BIOS during boot by pressing F2. Select **System Configuration** → **Watchdog Timer Support** → **Enable Watchdog Timer** in the BIOS setup program.

The Watchdog Timer feature is used to recover the operating system during the following instances:

- During POST of the computer to ensure that the computer initialization is completed properly by the BIOS/UEFI.
- During the transition from BIOS/UEFI to the operating system through an operating system Watchdog Timer driver.

In both instances, without any human intervention, the Watchdog Timer reacts when the computer is not responding. The Watchdog Timer is enabled and disabled under the BIOS setting **Watchdog Timer**.

TPM support

Windows 7 Professional for Embedded Systems supports TPM 1.2. For more information about TPM resources, see [https://technet.microsoft.com/en-us/library/cc749022\(v=ws.10\).aspx](https://technet.microsoft.com/en-us/library/cc749022(v=ws.10).aspx).

System shutdown

Click **Start**, and then click **Shut down** to shut down the Embedded Box PC.

System restart

Click **Start**, and click the arrow next to **Shut down**, and then click **Restart** to restart the Embedded Box PC.

LAN network configuration

1. Click **Start** and type `Network` in the search box.
2. Click **Network and Sharing Center** from the search result.
The **Network and Sharing Center** window appears.
3. From the left panel, click **Change adapter settings**.

WLAN network configuration

1. Click **Start** and type `Network` in the search box.
2. Click **Network and Sharing Center** from the search result.
The **Network and Sharing Center** window appears.



3. From the left panel, click **Change adapter settings**.

Bluetooth configuration

1. Click **Start** and type `Bluetooth` in the search box.
2. Click **Change Bluetooth settings** from the search result.
The **Bluetooth Settings** dialog box appears.

DW5580 network configuration

Follow the *Service Manual* to install and configure the DW5580 module and the corresponding carrier SIM card for the system. Once the module and the SIM card are installed, follow these steps to connect and disconnect from WWAN.

1. Click **Start** and type `Network` in the search box.
2. Click **Network and Sharing Center** from the search result.
The **Network and Sharing Center** window appears.
3. From the left panel, click **Change adapter settings**.
4. Locate the required WWAN connection.
5. Right-click the WWAN connection, and then select **Connect** or **Disconnect** to connect to or disconnect from the WWAN adapter, respectively.

Common port mappings on Embedded Box PC 5000 with Windows 7 Professional for Embedded Systems

Serial port mapping

The following table shows the serial port mapping at the bottom of the Embedded Box PC 3000 with Windows 7 Professional for Embedded Systems OS image.

Table 2. Serial port mapping

Number	Port Type	Connector	Device Node
1	RS232/485	DB9	COM1
2	Multi-function port (RS232/422)	7-in-1 cable	COM2
3	RS232/485	DB9	COM3

Windows Embedded Standard 7 P/E

Overview

The Embedded Box PC is shipped with Windows Embedded Standard 7 P/E. For more information on Windows 7 operating system, see <https://support.microsoft.com/en-us>.

Boot up and login

Before configuring the Windows Embedded Standard 7 P/E, connect a keyboard, mouse, and monitor to the Embedded Box PC.

1. Turn on the Embedded Box PC and login to Windows Embedded Standard 7 P/E.
2. Select regional settings.
3. Create a **User Account**.
4. Read and accept the EULA.
5. Select your preferred settings.

 **NOTE: Connect to a wireless network if available.**

Windows Embedded Standard 7 P/E. basic functions

BIOS update

Download the latest BIOS version from www.dell.com/support. Run the executable in the download package from the local machine.

Watchdog timer

The watchdog timer for Windows Embedded Standard 7 P/E. is enabled and disabled through the BIOS. Enter the BIOS during boot by pressing F2. Select **System Configuration** → **Watchdog Timer Support** → **Enable Watchdog Timer** in the BIOS setup program. The Watchdog Timer feature is used to recover the operating system during the following instances:

- During POST of the computer to ensure that the computer initialization is completed properly by the BIOS/UEFI.
- During the transition from BIOS/UEFI to the operating system through an operating system Watchdog Timer driver.

In both instances, without any human intervention, the Watchdog Timer reacts when the computer is not responding. The Watchdog Timer is enabled and disabled under the BIOS setting **Watchdog Timer**.

TPM support

Windows Embedded Standard 7 P/E. supports TPM 1.2. For more information, see <https://technet.microsoft.com/en-us/library/cc749022.aspx>.

System shutdown

Click the Start icon, then click **Shut down** to shut down the Embedded Box PC.

System restart

Click the Start icon, then click right-arrow next to the **Shut down** button and click **Restart**.

Configuring LAN/WLAN network

1. Click the Start icon then search for `Network`.
2. Open **Network and Sharing Center**.
3. Click **Change adapter settings** on the left panel.

to configure the LAN on the Embedded Box PC.

Configuring Bluetooth

1. Click the Start icon then search for `Bluetooth`.
2. Click **Change Bluetooth settings**.

Configuring WWAN (DW5580) network

 **NOTE:** For instruction on installing the WWAN card and SIM card, see the *Service manual* for your system at www.dell.com/support. After installing the WWAN module and SIM card:

1. Click the Start icon then search for `Network`.
2. Open **Network and Sharing Center**.
3. Click **Change adapter settings** on the left panel.
4. Locate the WWAN connection and select the entry to connect (or disconnect) to the WWAN module.

Common port mappings

Serial port mapping

The table lists the serial port mapping on the Embedded Box PC 3000 and the multifunction port cable, with the Dell factory installed Windows Embedded Standard 7 P/E OS.

Table 3. Serial port mapping

Serial port number	Port type	Connector	Device Node
1	RS232/485	DB9	COM1
2	RS232/422—multi-function port cable	7-in-1 cable	COM2



Serial port number	Port type	Connector	Device Node
3	RS232/485	DB9	COM3

Windows 10 Professional

Overview

The Embedded Box PC is shipped with Windows 10 Pro. For more information on Windows 10 operating system, see <https://support.microsoft.com/en-us>.

Boot up and login

Before configuring the Windows 10 Pro, connect a keyboard, mouse, and monitor to the Embedded Box PC.

1. Turn on the Embedded Box PC and login to Windows Pro.
2. Select regional settings.
3. Read and accept the EULA.
4. Create a **User Account**.
5. Select your preferred settings.

 **NOTE: Connect to a wireless network if available.**

Restoring Windows 10 Pro

Using the recovery OS image on the Boot partition, restore Windows 10 Pro on the Embedded Box PC to the factory image.

Before starting the Windows 10 Pro restore process, connect a keyboard, mouse, and monitor to the Embedded Box PC:

1. Boot to the desktop.
2. Click the start icon and power icon.
3. Press and hold the Shift key and click **Restart**.
The system will Boot into the recovery console.
4. Select **Troubleshoot**.
5. Select **Factory Image Restore**.
6. Select **Next**.
Wait until the default factory image is installed on the system.
7. Select **Finish**.

Windows 10 Pro basic functions

BIOS update

Download the latest BIOS version from www.dell.com/support. Run the executable in the download package from the local machine.

Watchdog timer

The watchdog timer for Windows 10 Pro is enabled and disabled through the BIOS. Enter the BIOS during boot by pressing F2. Select **System Configuration** → **Watchdog Timer Support** → **Enable Watchdog Timer** in the BIOS setup program.

The Watchdog Timer feature is used to recover the operating system during the following instances:

- During POST of the computer to ensure that the computer initialization is completed properly by the BIOS/UEFI.
- During the transition from BIOS/UEFI to the operating system through an operating system Watchdog Timer driver.

In both instances, without any human intervention, the Watchdog Timer reacts when the computer is not responding. The Watchdog Timer is enabled and disabled under the BIOS setting **Watchdog Timer**.

TPM support

Windows 10 Pro supports TPM 2.0. For more information, see <https://technet.microsoft.com/en-us/library/cc749022.aspx>.

System shutdown

Click the start icon then the power icon. Click **Shut down** to shut down the Embedded Box PC.

System restart

Click the start icon then the power icon. Click **Restart** to restart the Embedded Box PC.

LAN network

Click the Start icon then the settings icon. Click **Network & Internet** to configure the LAN on the Embedded Box PC.

Configuring WLAN network

Click the Start icon then the settings icon. Click **Devices** and the **Bluetooth** to configure the wireless devices on the Embedded Box PC.

Configuring WWAN (DW5580) network

 **NOTE:** For instruction on installing the WWAN card and SIM card, see the *Service manual* for your system at www.dell.com/support. After installing the WWAN module and SIM card:

1. Click the Start icon then the settings icon.
2. Click **Network & Internet**.
3. Locate the WWAN connection in the Wi-Fi section and connect (or disconnect) the WWAN module.

Common port mappings

Serial port mapping

The table lists the serial port mapping on the Embedded Box PC 3000 and the multifunction port cable, with the Dell factory installed Windows 10 Pro OS.

Table 4. Serial port mapping

Serial port number	Port type	Connector	Device Node
1	RS232/485	DB9	COM1
2	RS232/422—multi-function port cable	7-in-1 cable	COM2
3	RS232/485	DB9	COM3

Windows 10 IoT Enterprise LTSB 2015

Overview

The Embedded Box PC is shipped with Windows 10 IoT Enterprise LTSB 2015. For more information on Windows operating system, see <https://support.microsoft.com/en-us>.

Boot up and login

Before configuring the Windows 10 IoT Enterprise LTSB 2015, connect a keyboard, mouse, and monitor to the Embedded Box PC.

1. Turn on the Embedded Box PC and login to Windows.
2. Select regional settings.
3. Select your preferred settings.
4. Create a **User Account**.

 **NOTE:** Connect to a wireless network if available.



Restoring Windows 10 IoT Enterprise LTSB 2015

Using the recovery OS image on the Boot partition, restore Windows 10 IoT Enterprise LTSB 2015 on the Embedded Box PC to the factory image.

Before starting the Windows 10 IoT Enterprise LTSB 2015 restore process, connect a keyboard, mouse, and monitor to the Embedded Box PC:

1. Boot to the desktop.
2. Click the start icon and power icon.
3. Press and hold the Shift key and click **Restart**.
The system will Boot into the recovery console.
4. Select **Troubleshoot**.
5. Select **Factory Image Restore**.
6. Select **Next**.
Wait until the default factory image is installed on the system.
7. Select **Finish**.

Windows 10 IoT Enterprise LTSB 2015 basic functions

BIOS update

Download the latest BIOS version from www.dell.com/support. Run the executable in the download package from the local machine.

Watchdog timer

The watchdog timer for Windows 10 IoT Enterprise LTSB 2015 is enabled and disabled through the BIOS. Enter the BIOS during boot by pressing F2. Select **System Configuration** → **Watchdog Timer Support** → **Enable Watchdog Timer** in the BIOS setup program.

The Watchdog Timer feature is used to recover the operating system during the following instances:

- During POST of the computer to ensure that the computer initialization is completed properly by the BIOS/UEFI.
- During the transition from BIOS/UEFI to the operating system through an operating system Watchdog Timer driver.

In both instances, without any human intervention, the Watchdog Timer reacts when the computer is not responding. The Watchdog Timer is enabled and disabled under the BIOS setting **Watchdog Timer**.

TPM support

Windows 10 IoT Enterprise LTSB 2015 supports TPM 2.0. For more information, see <https://technet.microsoft.com/en-us/library/cc749022.aspx>.

System shutdown

Click the start icon then the power icon. Click **Shut down** to shut down the Embedded Box PC.

System restart

Click the start icon then the power icon. Click **Restart** to restart the Embedded Box PC.

LAN network

Click the Start icon then the settings icon. Click **Network & Internet** to configure the LAN on the Embedded Box PC.

Configuring WLAN network

Click the Start icon then the settings icon. Click **Devices** and the **Bluetooth** to configure the wireless devices on the Embedded Box PC.

Configuring WWAN (DW5580) network

 **NOTE:** For instruction on installing the WWAN card and SIM card, see the *Service manual* for your system at www.dell.com/support. After installing the WWAN module and SIM card:

1. Click the Start icon then the settings icon.
2. Click **Network & Internet**.
3. Locate the WWAN connection in the Wi-Fi section and connect (or disconnect) the WWAN module.

Common port mappings

Serial port mapping

The table lists the serial port mapping on the Embedded Box PC 3000 and the multifunction port cable, with the Dell factory installed Windows 10 IoT Enterprise LTSB 2015 OS.

Table 5. Serial port mapping

Serial port number	Port type	Connector	Device Node
1	RS232/485	DB9	COM1
2	RS232/422—multi-function port cable	7-in-1 cable	COM2
3	RS232/485	DB9	COM3

Recommended drivers and applications for Embedded Box PC running Windows operating system

 **NOTE:** For more information about installing and configuring the Windows operating systems, see msdn.microsoft.com.

Dell recommends installing the drivers and applications required for the Embedded Box PC from www.dell.com/support in the following sequence:

1. Intel Mobile Chipset Software Installation Utility
2. Critical Microsoft Quick Fix Engineering (QFE)
3. Graphics
4. Intel Management Technology
5. Audio
6. Integrated wired network adapter
7. Wireless local network adapters and Bluetooth (optional)
8. USB 3.0
9. ZigBee (optional)
10. CANbus (optional)

Intel Mobile Chipset Software Installation Utility

1. Go to www.dell.com/support.
2. Click **Product support**, enter the Service Tag of the Embedded Box PC, and then click **Submit**.

 **NOTE:** If you do not have the Service Tag, use the auto-detect feature or manually browse for the Embedded Box PC model.

3. Click **Drivers & downloads** → **Find it myself**.
4. Scroll down the page and expand **Chipset**.
5. Click **Download** to download the Intel Mobile Chipset Software Installation Utility.
6. After the download is complete, navigate to the folder where you saved the chipset driver file.
7. Double-click the chipset driver file icon and follow the instructions on the screen.



Critical Microsoft QFEs

Dell recommends installing all the latest available fixes specific to Embedded Box PC through **Windows Update** or from www.microsoft.com.

Graphics

1. Go to www.dell.com/support.
2. Click **Product support**, enter the Service Tag of the Embedded Box PC, and then click **Submit**.
 **NOTE: If you do not have the Service Tag, use the auto-detect feature or manually browse for the Embedded Box PC model.**
3. Click **Drivers & downloads** → **Find it myself**.
4. Scroll down the page and expand **Video**.
5. Click **Download** to download the graphics driver file.
6. After the download is complete, navigate to the folder where you saved the graphics driver file.
7. Double-click the graphics driver file icon and follow the instructions on the screen.

Intel Management Technology

1. Go to www.dell.com/support.
2. Click **Product support**, enter the Service Tag of the Embedded Box PC, and then click **Submit**.
 **NOTE: If you do not have the Service Tag, use the auto-detect feature or manually browse for the Embedded Box PC model.**
3. Click **Drivers & downloads** → **Find it myself**.
4. Scroll down the page and expand **Chipset**.
5. Click **Download** to download the Intel TXEI driver.
6. After the download is complete, navigate to the folder where you saved the Intel TXEI driver file.
7. Double-click the Intel TXEI driver file icon and follow the instructions on the screen.

Audio

1. Go to www.dell.com/support.
2. Click **Product support**, enter the Service Tag of the Embedded Box PC, and then click **Submit**.
 **NOTE: If you do not have the Service Tag, use the auto-detect feature or manually browse for the Embedded Box PC model.**
3. Click **Drivers & downloads** → **Find it myself**.
4. Scroll down the page and expand **Audio**.
5. Click **Download** to download the HD Audio driver.
6. After the download is complete, navigate to the folder where you saved the HD Audio driver file.
7. Double-click the HD Audio driver file icon and follow the instructions on the screen.

Integrated wired network adapter

1. Go to www.dell.com/support.
2. Click **Product support**, enter the Service Tag of the Embedded Box PC, and then click **Submit**.
 **NOTE: If you do not have the Service Tag, use the auto-detect feature or manually browse for the Embedded Box PC model.**
3. Click **Drivers & downloads** → **Find it myself**.
4. Scroll down the page and expand **Network**.
5. Click **Download** to download the LAN driver.
6. After the download is complete, navigate to the folder where you saved the LAN driver file.
7. Double-click the LAN driver file icon and follow the instructions on the screen.

 **NOTE: Enable Windows Update and connect to Internet after installing the integrated wired network controller driver.**

Wireless local network adapters and Bluetooth

1. Go to www.dell.com/support.
2. Click **Product support**, enter the Service Tag of the Embedded Box PC, and then click **Submit**.

 **NOTE: If you do not have the Service Tag, use the auto-detect feature or manually browse for the Embedded Box PC model.**

3. Click **Drivers & downloads** → **Find it myself**.
4. Scroll down the page and expand **Network**.
5. Click **Download** to download the Wireless LAN and Bluetooth device drivers.
6. After the download is complete, navigate to the folder where you saved the LAN driver file.
7. Double-click the LAN driver file icon and follow the instructions on the screen.

USB 3.0

1. Go to www.dell.com/support.
2. Click **Product support**, enter the Service Tag of the Embedded Box PC, and then click **Submit**.

 **NOTE: If you do not have the Service Tag, use the auto-detect feature or manually browse for the Embedded Box PC model.**

3. Click **Drivers & downloads** → **Find it myself**.
4. Scroll down the page and expand **Chipset**.
5. Click **Download** to download the USB 3.0 driver.
6. After the download is complete, navigate to the folder where you saved the USB 3.0 driver file.
7. Double-click the USB 3.0 driver file icon and follow the instructions on the screen.

ZigBee

1. Go to www.dell.com/support.
2. Click **Product support**, enter the Service Tag of the Embedded Box PC, and then click **Submit**.

 **NOTE: If you do not have the Service Tag, use the auto-detect feature or manually browse for the Embedded Box PC model.**

3. Click **Drivers & downloads** → **Find it myself**.
4. Scroll down the page and expand **Network**.
5. Click **Download** to download the ZigBee 3.0 driver.
6. After the download is complete, navigate to the folder where you saved the ZigBee 3.0 driver file.
7. Double-click the ZigBee 3.0 driver file icon and follow the instructions on the screen.

CANbus

1. Go to www.dell.com/support.
2. Click **Product support**, enter the Service Tag of the Embedded Box PC, and then click **Submit**.

 **NOTE: If you do not have the Service Tag, use the auto-detect feature or manually browse for the Embedded Box PC model.**

3. Click **Drivers & downloads** → **Find it myself**.
4. Scroll down the page and expand **Chipset**.
5. Click **Download** to download the CANbus driver.
6. After the download is complete, navigate to the folder where you saved the CANbus driver file.
7. Double-click the CANbus driver file icon and follow the instructions on the screen.



Specifications

Dimension and weight	
Width	236.50 mm (9.31 in)
Depth	160.80 mm (6.33 in)
Height	60 mm (2.36 in)
Weight	2 kg (4.41 lb)
System information	
Model number	Dell Embedded Box PC 3000
Processor	<ul style="list-style-type: none"> Intel Atom E3825 Intel Atom E3827 Intel Atom E3845
Operating systems supported	<ul style="list-style-type: none"> Windows 7 Professional SP1 64-bit Windows 7 Professional for Embedded Systems SP1 64-Bit Windows Embedded Standard 7 P 64-bit Windows Embedded Standard 7 E 64-bit Windows 10 Professional 64-bit Windows 10 IoT Enterprise LTSB 2015 64-bit Ubuntu Desktop 16.04
Storage	
Hard drive	One 2.5-inch SATA hard drive
Solid-state drive	One M.2 solid-state drive with interposer

 **NOTE: Embedded Box PC is shipped with either hard drive or solid-state drive, depending on the configuration ordered.**

Memory	
Slots	One DIMM slot
Type	DDR3L
Speed	1333 MHz
Configurations supported	<ul style="list-style-type: none"> 4 GB 8 GB

Ports and connectors	
Audio/video	<ul style="list-style-type: none"> One VGA port One DisplayPort
Multi-Function port cable (optional)	<ul style="list-style-type: none"> One line-in port One line-out port

Ports and connectors

	<ul style="list-style-type: none">• One microphone port• Two PS/2 ports• One GPIO port• One RS232/RS422 port• Multi-function port (male)
Network	<ul style="list-style-type: none">• Two RJ45 ports• Two wireless antenna ports• Two mobile broadband antenna ports
I/O port	<ul style="list-style-type: none">• One CANbus port (optional)• Two RS232/RS485 ports
USB	<ul style="list-style-type: none">• One USB 3.0 port• Four USB 2.0 ports

Communications

WiFi	Dual-band 802.11b/g/n/ac
Bluetooth	Bluetooth 4.1 LE

Power requirements

Power input voltage/current	12 VDC/4.10 A-26 VDC/1.90 A
-----------------------------	-----------------------------

RTC coin-cell battery (lithium ion)

Type	CR-2032H	BR-2032	Others
Manufacturer	<ul style="list-style-type: none">• Hitachi Ltd.• Maxell Ltd.	Panasonic Corp.	Varies depending on the battery type
Maximum abnormal charging rate:			
Voltage	3 V	3 V	3 V
Current	10 mA	10 mA	10 mA
Standard	UL1642	UL1642	UL1642
Approval	UL (MH12568)	UL (MH12210)	UL (MHxxxxx)

Environmental requirements

Temperature range:

Operating: Hard drive	0°C to 40°C (32°F to 104°F)
Operating: Solid-state drive	0°C to 50°C (32°F to 122°F)
Non-operating	-40°C to 65°C (-40°F to 149°F)

Relative humidity (maximum):

Operating	10% to 90% (non-condensing)
Non-operating	5% to 95% (non-condensing)

Altitude (maximum, unpressurized):



Environmental requirements

Operating	-15.20 m to 5000 m (-50 ft to 16,404 ft)
Storage	-15.20 m to 10,668 m (Sea level to 35,000 ft)
IP level	IP 30

Activating your mobile broadband service

 **NOTE:** For more information about installing the SIM card, see the Embedded Box PC Service Manual at www.dell.com/support.

1. Turn on the Embedded Box PC.
2. Follow these steps to connect to the mobile broadband network:

 **NOTE:** To activate your mobile broadband service, contact your service provider with the following information:

Windows OS

- a. From the task bar select the Network icon and then select **Cellular**.
The **Cellular** page is displayed.
- b. Select your **Mobile Broadband Carrier** to expand the options.
- c. Select **Advanced Options**.
The options are displayed.
- d. Make a note of the **International Mobile Equipment Identity (IMEI)** and the **Integrated Circuit Card Identifier (ICCID)**.

Ubuntu OS

Open a **Terminal** window.

- a. Go to super user mode by entering: `$sudo su -`
- b. Configure the Mobile Broadband connection profile:

```
#nmcli con add type gsm ifname ttyACM3 con-name <connection name> apn <apn> user <user name> password <password>
```

- c. Connect to the mobile network: `#nmcli con up <connection name>`

To disconnect from the mobile network: `#nmcli con down <connection name>`.

Using the Multi-function port cable

NOTE: The Multi-function port cable is sold separately.

You can use the Multi-function port cable to increase the number of available ports on the Embedded Box PC.

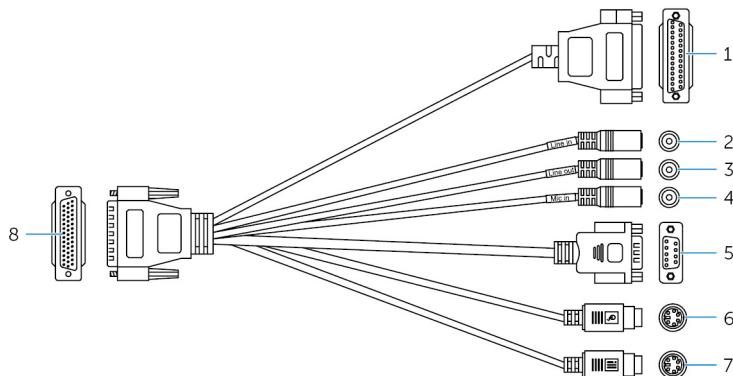

Features

1	GPIO port	Connect a GPIO enabled device or dongle.
2	Line-in port	Connect recording or playback devices.
3	Line-out port	Connect to audio-output devices such as speakers and amplifiers.
4	Microphone port	Connect an external microphone to provide sound input.
5	RS232/RS422 port two (configurable in the BIOS)	Connect a RS232/RS422 cable. For more information, see RS232/RS422 connector mapping.
6	PS/2 connector (mouse)	Connect a PS/2 mouse.
7	PS/2 connector (keyboard)	Connect a PS/2 keyboard.
8	Multi-function port	Connect the Multi-function port cable to the Multi-function port on the Embedded Box PC.

The following figure shows the GPIO-port pin number mapping.

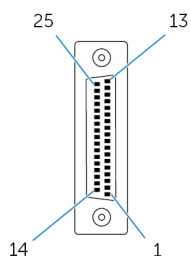

The following table shows the GPIO-port pin definition details.

Pin	Signal	Pin	Signal
25	NC	13	NC
24	NC	12	NC
23	NC	11	NC
22	NC	10	NC
21	NC	9	NC
20	NC	8	GND
19	TCA9555 P15	7	5 V
18	TCA9555 P14	6	TCA9555 P05
17	TCA9555 P13	5	TCA9555 P04
16	TCA9555 P12	4	TCA9555 P03
15	TCA9555 P11	3	TCA9555 P02
14	TCA9555 P10	2	TCA9555 P01
		1	TCA9555 P00

The following figure shows the Multi-function port pin number mapping on the Embedded Box PC.

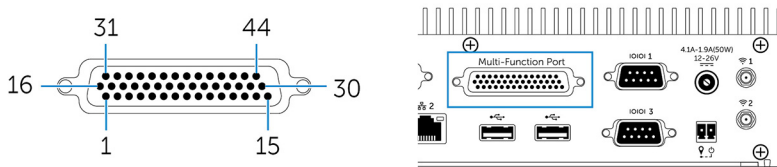

The following table shows the Multi-function port pin definition details.

Pin	Signal	Pin	Signal	Pin	Signal
1	LINE1_JD	16	FRONT_JD	31	LINE1_RIN
2	MIC1_JD	17	LINEOUT_R	32	GND
3	MIC_RIN	18	GND	33	LINE1_LIN
4	GND	19	LINEOUT_L	34	+5V
5	MIC_LIN	20	GND	35	TCA9555 P03
6	TCA9555 P05	21	TCA9555 P04	36	TCA9555 P00
7	TCA9555 P02	22	TCA9555 P01	37	TCA9555 P13
8	TCA9555 P15	23	TCA9555 P14	38	TCA9555 P10
9	TCA9555 P12	24	TCA9555 P11	39	DNC
10	MSCK	25	DNC	40	NRIB#
11	GND	26	GND	41	NRTSB#
12	MSDA	27	NCTSB#	42	COM2_GND
13	KBDA	28	NDSRB#	43	NTXDB_422RXP
14	VCC_PS2	29	NDTRB#_422RXN	44	NDCDB#_422TXN
15	KBCK	30	NRXDB_422TXP		

 **NOTE: DNC indicates Do Not Connect.**



The following figure shows the Multi-function port pin number mapping on the Multi-function port cable.

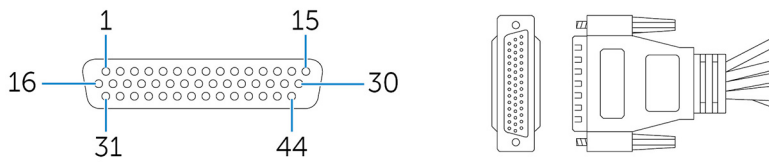

The following table shows the Multi-function port pin definition details.

Pin	Signal	Pin	Signal	Pin	Signal
1	LINE1_JD	16	FRONT_JD	31	LINE1_RIN
2	MIC1_JD	17	LINEOUT_R	32	GND
3	MIC_RIN	18	GND	33	LINE1_LIN
4	GND	19	LINEOUT_L	34	+5V
5	MIC_LIN	20	GND	35	TCA9555 P03
6	TCA9555 P05	21	TCA9555 P04	36	TCA9555 P00
7	TCA9555 P02	22	TCA9555 P01	37	TCA9555 P13
8	TCA9555 P15	23	TCA9555 P14	38	TCA9555 P10
9	TCA9555 P12	24	TCA9555 P11	39	DNC
10	MSCK	25	DNC	40	NRIB#
11	GND	26	GND	41	NRTSB#
12	MSDA	27	NCTSB#	42	COM2_GND
13	KBDA	28	NDSRB#	43	NTXDB_422RXP
14	VCC_PS2	29	NDTRB#_422RXN	44	NDCDB#_422TXN
15	KBCK	30	NRXDB_422TXP		

 **NOTE: DNC indicates Do Not Connect.**

Setting up the ZigBee Dongle

1. Shut down the Embedded Box PC.
2. Connect the ZigBee dongle to any external USB port on the Embedded Box PC.

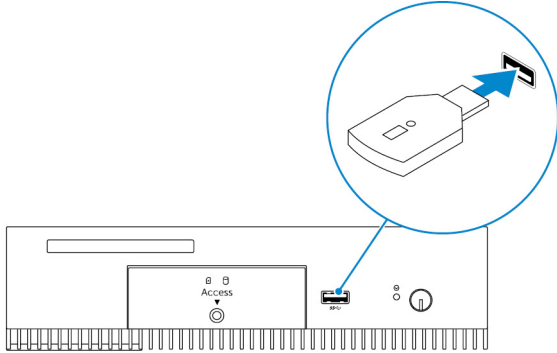

3. Turn on the Embedded Box PC and complete the setup.



NOTE: For ZigBee development information, see the SiLabs developer website at www.silabs.com or contact the network system's application provider.

Connector kit

Remote Power Connector

Use the remote power connector to install a remote power switch.

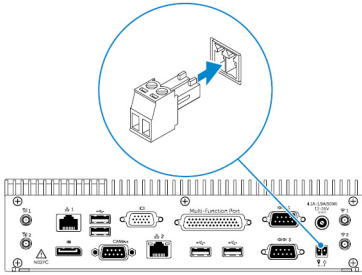

BIOS defaults

General

Item	Default value
System Information	
BIOS Version	Not applicable
Service Tag	Not applicable
Asset Tag	Not applicable
Ownership Tag	Not applicable
Manufacturing Date	Not applicable
Ownership Date	Not applicable
Express Service Code	Not applicable
Memory Information	
Memory Installed	Not applicable
Memory Available	Not applicable
Memory Speed	Not applicable
Memory Channel Mode	Not applicable
Memory Technology	Not applicable
Each DIMM Size	Not applicable
PCI Information	
Slot1 Bottom Riser Module	Not applicable
Slot2	Not applicable
Slot3	Not applicable
Slot4 Upper Riser Module	Not applicable
Processor Information	
Processor Type	Not applicable



Item	Default value
Core Count	Not applicable
Processor ID	Not applicable
Current Clock Speed	Not applicable
Minimum Clock Speed	Not applicable
Maximum Clock Speed	Not applicable
Processor L2 Cache	Not applicable
Processor L3 Cache	Not applicable
HT Capable	Not applicable
64-Bit Technology	Not applicable
Device Information	
SATA-1	Not applicable
SATA-2	Not applicable
LOM MAC Address	Not applicable
Video Controller	Not applicable
Video BIOS version	Not applicable
Audio Controller	Not applicable
Wi-Fi Device	Not applicable
Cellular Device	Not applicable
Bluetooth Device	Not applicable
Boot Sequence	
Boot Sequence - Depends on installed boot devices	Not applicable
Boot List option [Legacy/UEFI]	Legacy
Enable Legacy Option ROMs	Enabled
Date/Time	
Date	Not applicable
Time	Not applicable

System configuration (BIOS level 1)

Item	Default value
Integrated NIC	
Enable UEFI Network Stack	Disabled
[Disabled, Enabled, Enabled w/PXE]	Enabled w/PXE
Integrated NIC 2	
Enable UEFI Network Stack	Disabled
[Disabled, Enabled, Enabled w/PXE]	Enabled w/PXE
Serial Port1 — [Disable / RS-232 / RS-422/485 /RS-485]	RS-232
Serial Port2 — [Disable / RS-232 / RS-422/485 /RS-485]	RS-232
Serial Port3 — [Disable / RS-232 / RS-422/485 /RS-485]	RS-232
Serial Port4 — [Disable / RS-232 / RS-422/485 /RS-485]	RS-232
GPIO Module — GPIO 8 OUT [Enable/Disable]	Enabled
GPIO Module — GPIO 8 IN [Enable/Disable]	Enabled
SATA Operation — [Disabled/AHCI/RAID On]	RAID On
Drives — SATA-1: [Enable/Disable]	Enabled
Drives — SATA-2: [Enable/Disable]	Enabled
SMART Reporting — [Enable/Disable]	Disabled
USB Configuration	
Enable Boot Support [Enable/Disable]	Enabled
Top Port 1 [Enable/Disable]	Enabled
Top Port 2 [Enable/Disable]	Enabled
Top Port 3 [Enable/Disable]	Enabled
Top Port 4 [Enable/Disable]	Enabled
Bottom Port1 [Enable/Disable]	Enabled
Bottom Port2 [Enable/Disable]	Enabled
Audio	
Enable Audio [Enable/Disable]	Enabled



Item	Default value
Enable Microphone [Enable/Disable]	Enabled
Miscellaneous Devices — Enable PCI Riser Module [Enable/Disable]	Enabled
Watchdog Timer Support — Enable Watchdog Timer [Enable/Disable]	Disabled
WLAN Region Code — [North America (FCC)/China,South Asia/Europe/Taiwan/Japan/Australia/Indonesia/Rest of world]	Rest of world
Power Button — [Enable/Disable]	Disabled

Video

Item	Default value
[DisplayPort/VGA]	VGA
[Auto/Intel HD Graphics]	Auto

Security (BIOS level 1)

Item	Default value
Admin Password — Text entry for old password (grayed out when no password set), new password, and confirm new password	Blank
System Password — Text entry for old password (grayed out when no password set), new password, and confirm new password	Blank
Strong Password — [Enable/Disable]	Disabled
Password Configuration	
Admin Password Min	4
Admin Password Max	32
System Password Min	4
System Password Max	32
Password Bypass — [Disabled/Reboot Bypass]	Disabled
Password Change — Allow Non-Admin Password Changes [Enable/Disable]	Enabled
UEFI Capsule Firmware Updates — Enable UEFI Capsule Firmware Updates [Enable/Disable]	Enabled

TPM 1.2 Security

Item	Default value
TPM 1.2 Security [Enable/Disable]	Enabled
TPM On	Enabled
PPI Bypass for Enable Commands	Disabled
PPI Bypass for Disable Commands	Disabled
Clear [Enable/Disable]	Disabled
TPM 2.0 Security	
TPM 2.0 Security [Enable/Disable]	Enabled
TPM On	Enabled
PPI Bypass for Enable Commands	Disabled
PPI Bypass for Disable Commands	Disabled
Attestation Enable [Enable/Disable]	Enabled
Key Storage Enable [Enable/Disable]	Enabled
SHA-256	Enabled
Clear [Enable/Disable]	Not applicable
Computrace(R) — [Deactivate/Disable/Enable]	Deactivate
Chassis Intrusion — [Disable/Enable/On-Silent]	Disable
CPU XD Support — [Enable/Disable]	Enabled
OROM Keyboard Access — [Enable/One Time Enable/Disable]	Enabled
Admin Setup Lockout — [Enable/Disable]	Disabled

Secure boot

Item	Default value
Secure Boot Enable — [Enable/Disable]	Disabled
Expert Key Management	
Enable Custom Mode [Enable/Disable]	Disabled
Custom Mode Key Management {PK/KEK/db/dbx}	Platform Specific



Intel software guard extensions

Item	Default value
Intel SGX Enable — [Enable/Disable]	Disabled
Enclave Memory Size — [32MB/64MB/128MB]	128 MB

Performance

Item	Default value
Enable Multi Core Support — [Enable/Disable]	Enabled
Intel SpeedStep — [Enable/Disable]	Enabled
C-States Control — [Enable/Disable]	Enabled
Enable CPUID Limit — [Enable/Disable]	Disabled
Intel TurboBoost — [Enable/Disable]	Enabled
Hyperthread control — [Enable/Disable]	Enabled

Power management

Item	Default value
AC Recovery (Desktop) — [Power Off/Power On/Last Power State]	Last Power State
Auto On Time	
Time Selection HH/MM [AM/PM]	12:00AM
Day Selection [Disabled/Every Day/Weekdays/Select Days]	Disabled
Under [Select Days] when Enabled [Sunday/Monday.../Saturday]	Not applicable
USB Wake Support — [Enable/Disable]	Enabled
Wake on LAN/WLAN	
[Disabled/WLAN Only/LAN Only/LAN or WLAN/LAN with PXE Boot]	Disabled
Block Sleep(S3 state) [Enable/Disable]	Disabled

POST behavior

Item	Default value
Numlock LED — [Enable/Disable]	Enabled
Keyboard Errors — Enable Keyboard Error Detection [Enable/Disable]	Enabled
Fastboot — [Minimal/Thorough/Auto]	Thorough
Extend BIOS POST Time — [0 seconds/5 seconds/10 seconds]	0 Seconds
Warnings and Errors — [Disable/Continue on Warnings/Continue on Warnings and Errors]	Continue on Warnings and Errors

Virtualization support (BIOS level 1)

Item	Default value
Intel Virtualization Technology — [Enable/Disable]	Enabled
VT for Direct I/O — [Enable/Disable]	Enabled
Trusted Execution — [Enable/Disable]	Disabled

Wireless

Item	Default value
Wireless Device Enable — WLAN/WiGig [Enable/Disable]	Enabled

Maintenance

Item	Default value
Service Tag — <System Service Tag>, text entry capability when blank	Not applicable
Asset Tag — <System Asset Tag>, text entry capability	Not applicable
SERR Messages — [Enable/Disable]	Enabled
BIOS Downgrade — [Enable/Disable]	Enabled
Data Wipe on Next Boot — [Enable/Disable]	Disabled
BIOS Recovery from Hard Drive — [Enable/Disable]	Enabled



System logs

Item	Default value
List of BIOS events with "Clear Log" button to clear the log	Not applicable

Contacting Dell

To contact Dell for sales, technical assistance, or customer service issues:

1. Go to www.dell.com/contactdell.
2. Verify your country or region in the drop-down list at the bottom of the page.
3. Select the appropriate service or support link based on your requirement or choose the method of contacting Dell that is convenient for you.

Dell provides several online and telephone-based support and service options. Availability varies by country and product, and some services may not be available in your area.

 **NOTE: If you do not have an active internet connection, you can find contact information on your purchase invoice, packing slip, bill, or Dell product catalog.**

